

KENWOOD

AM-FM STEREO RECEIVER

103AR

INSTRUCTION MANUAL

KENWOOD CORPORATION

Before applying power

Caution: Read this section carefully to ensure safe operation.

103AR (En)

Units are designed for operation as follows.

U.S.A. and Canada AC 120 V only
Australia AC 240 V only

China AC 220 V only
*Other countries AC 110-120/220-240 V switchable

*AC voltage selection

The AC voltage selector switch on the rear panel is set to the voltage that prevails in the area to which the unit is shipped. Before connecting the power cord to your AC outlet, make sure that the setting position of this switch matches your line voltage. If not, it must be set to your voltage in accordance with the following direction.

Note:
Our warranty does not cover damage caused by excessive line voltage due to improper setting of the AC voltage selector switch.

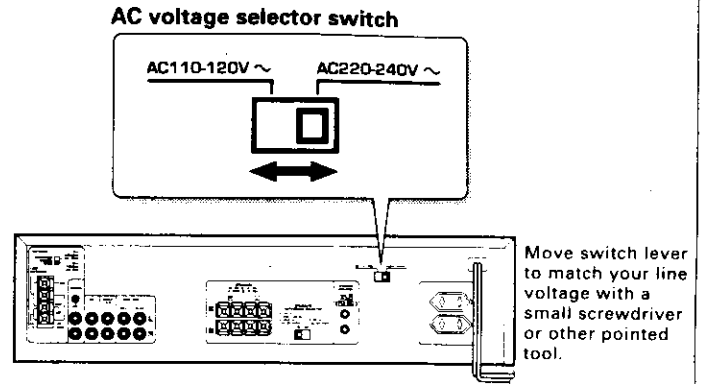

Safety precautions

Caution: Read this section carefully to ensure safe operation.

WARNING: TO PREVENT FIRE OR ELECTRIC SHOCK, DO NOT EXPOSE THIS APPLIANCE TO RAIN OR MOISTURE.

	<p>CAUTION RISK OF ELECTRIC SHOCK DO NOT OPEN</p>	<p>CAUTION: TO REDUCE THE RISK OF ELECTRIC SHOCK, DO NOT REMOVE COVER (OR BACK). NO USER-SERVICEABLE PARTS INSIDE, REFER SERVICING TO QUALIFIED SERVICE PERSONNEL.</p>
	<p>THE LIGHTNING FLASH WITH ARROWHEAD SYMBOL, WITHIN AN EQUILATERAL TRIANGLE, IS INTENDED TO ALERT THE USER TO THE PRESENCE OF UNINSULATED "DANGEROUS VOLTAGE" WITHIN THE PRODUCT'S ENCLOSURE THAT MAY BE OF SUFFICIENT MAGNITUDE TO CONSTITUTE A RISK OF ELECTRIC SHOCK TO PERSONS.</p>	
	<p>THE EXCLAMATION POINT WITHIN AN EQUILATERAL TRIANGLE IS INTENDED TO ALERT THE USER TO THE PRESENCE OF IMPORTANT OPERATING AND MAINTENANCE (SERVICING) INSTRUCTIONS IN THE LITERATURE ACCOMPANYING THE APPLIANCE.</p>	

Unpacking

Unpack the unit carefully and make sure that all accessories are put aside so they will not be lost. Examine the unit for any possibility of shipping damage. If your unit is damaged or fails to operate, notify your dealer immediately. If your unit was shipped to you directly, notify the shipping company without delay. Only the consignee (the person or company receiving the unit) can file a claim against the carrier for shipping damage. We recommend that you retain the original carton and packing materials for use should you transport or ship the unit in the future.

Accessories

<p>FM indoor antenna (1)</p>	<p>AM loop antenna (1)</p>	<p>Loop antenna stand (1)</p>
<p>Remote control unit (1)</p>	<p>Batteries (R6/AA) (2)</p>	

Special features

Station preset

This unit incorporates a function for storing received stations in preset memory with a simple operation. It is very convenient to preset the stations you like. The preset stations can be recalled also very easily.

- 15

Speaker system

Setting the Speaker Impedance Selector to match the impedance of your speakers allows you to take full advantage of your speaker's performance characteristics by driving them under the best possible conditions.

We've also included 2 sets of speaker terminals so you can connect two different sounding speaker systems, or use two sets of speakers at once (only when both sets of speakers have an impedance of 8 ohms or more).

- 6

Remote controllable audio function

By connecting KENWOOD source components such as a cassette deck and CD player through system control connection, the basic operations of these components can be controlled from the remote control unit provided with this unit. A single remote control unit can control the entire audio system easily.

- 9

Contents

Caution : Read the pages marked  carefully to ensure safe operation.

Before applying power

! Before applying power 2

! Safety precautions 2

Special features

System connections

FM DE-EMPHASIS / CHANNEL SPACE switch 4

Controls and indicators

Playing music

..... 7

Sound adjustment functions

..... 8

Recording

..... 11

Broadcast reception

..... 12

Receiving broadcast stations 13

Receiving radio stations by specifying its frequency 13

Storing radio stations in memory (Station preset) 14

Receiving a preset station 15

Receiving all preset stations in order 15

..... 16

..... 17

In case of difficulty

! Specifications

Connections of Audio and Video components

Make connection as shown below.
 When connecting the related system components, refer also to the instruction manuals of the related components.
 Do not plug in the power lead until all connections are completed.

Malfunction of microcomputer

If operation is not possible or erroneous display appears even though all connections have been made properly, reset the microcomputer referring to "In case of difficulty".

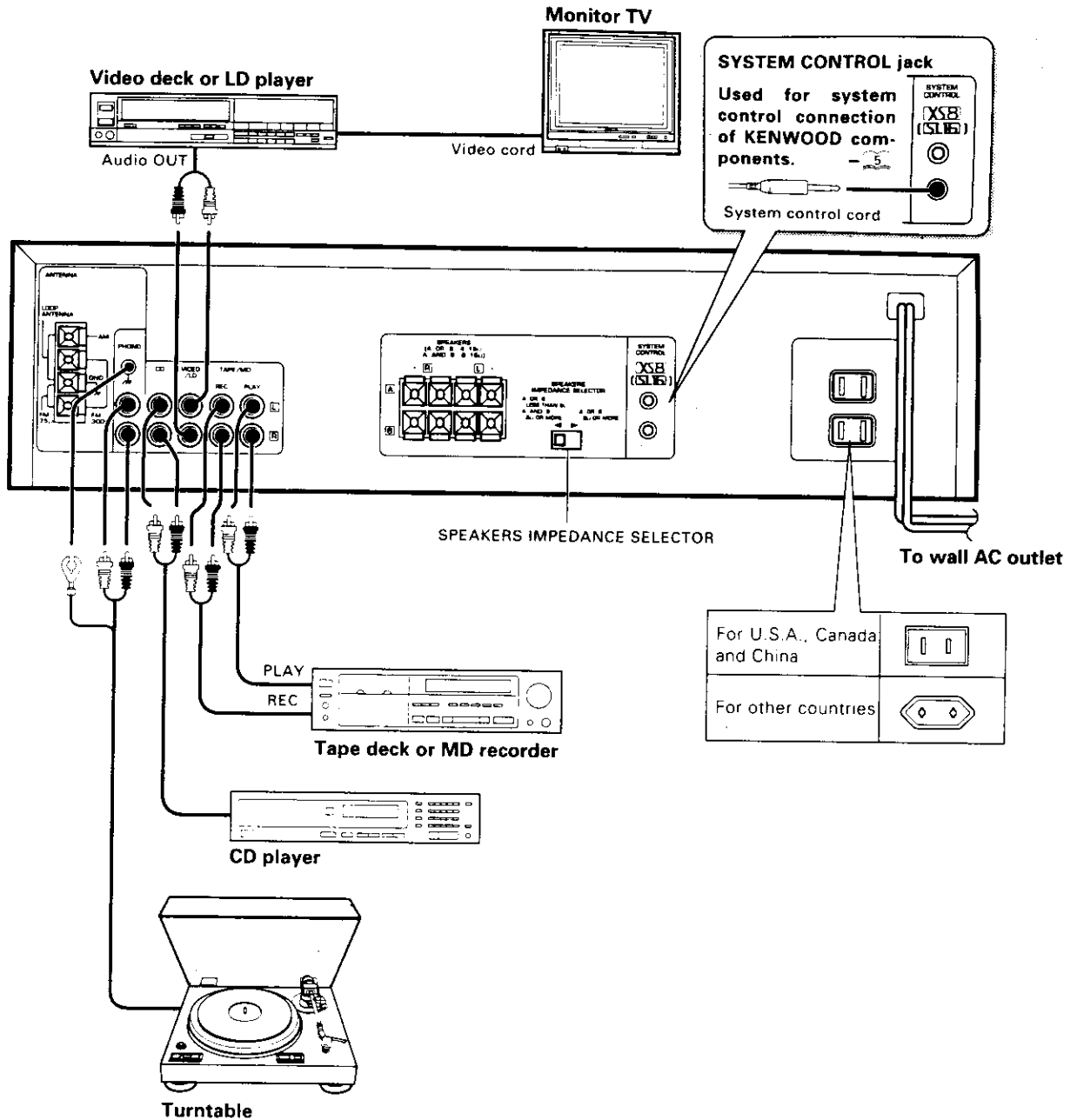

About the system control connections

Connecting system control cords after connecting a KENWOOD audio component system lets you take advantage of convenient system control operations.

There are two KENWOOD system control modes. Make connections according to the groups of terminal symbols shown below.

[XS8] Mode: lets you combine **[XR]**, **[XS]**, and **[XS8]** terminals

[SL16] Mode: for **[SL16]** terminals only

This unit is compatible with both **[XS8]** and **[SL16]** modes. It comes from the factory set to the **[XS8]** mode. To switch to the **[SL16]** mode, follow the instructions in "SWITCHING FROM [XS8] TO [SL16]" below.

EXAMPLE: [XS8] mode connections

The underlined portion represents the setting of the system control mode.

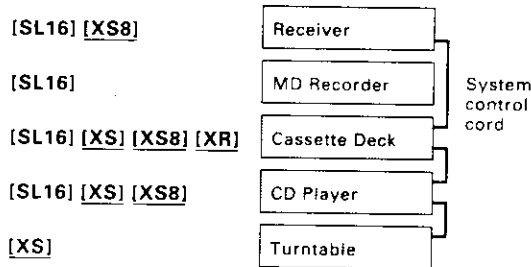

EXAMPLE: [SL16] mode connections

The underlined portion represents the setting of the system control mode.

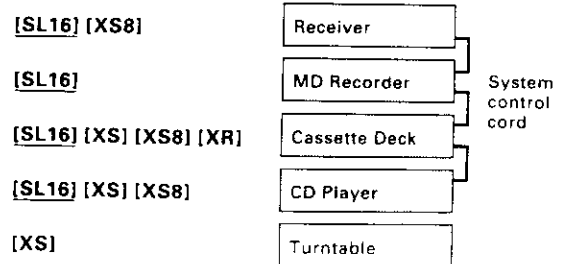

- Some CD players and cassette decks are not compatible with the [SL16] system control mode. Be sure to use the [XS8] system control mode when making system connections with equipment that is not [SL16] compatible.
- Some MD players are not system control compatible. You cannot make system control connections to this kind of equipment.



* [SL16] equipment cannot be combined with [XR], [XS], and [XS8] equipment for system operations. If your equipment consists of this kind of combination, please do not connect any system control cords. Even without system control cords, normal operations can be carried out without affecting performance.

2 Do not connect system control cords to any components other than those specified by KENWOOD. It may cause a malfunction and damage your equipment.

3 Be sure the system control plugs are inserted all the way in to the system control terminals.

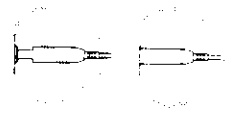

ABOUT THE SYSTEM CONTROL OPERATIONS

Remote Control (Except [SL16])

Lets you operate source components with the system remote supplied with this unit.

Automatic Operation (Except [XR] equipment)

When you start playback from a source component, the input selector on this unit switches to that component automatically.

Synchronized Recording (Except [XR] equipment)

Lets you synchronize recording with the start of playback when recording from CD, MD, or analog discs.

SWITCHING FROM [XS8] TO [SL16]

You can easily change the system control mode with the following operation. Do this operation after completing all connections.

Switching to [SL16]: Unplug the AC power cord from the wall outlet, then plug it back in while holding down the AUTO/MANUAL key.

Switching back to [XS8]: Unplug the AC power cord from the wall outlet, then plug it back in while holding down the BAND key.

- This operation will not affect items stored in the memory.



The system control mode will revert to [XS8] if the power cord is disconnected from the AC outlet for three consecutive days. If you would like to make the unit completely (and permanently) [SL16] compatible, please consult your nearest retailer or the KENWOOD Marketing Department.



- 1 Connect all cords firmly. If connections are loose, there could be loss of sound or noise produced.
- 2 When plugging and unplugging connection cords, be sure to first remove the power cord from the AC outlet. Plugging / unplugging connection cords without removal of the power cord can cause malfunctions or damage to the unit.

6 Connection of speakers

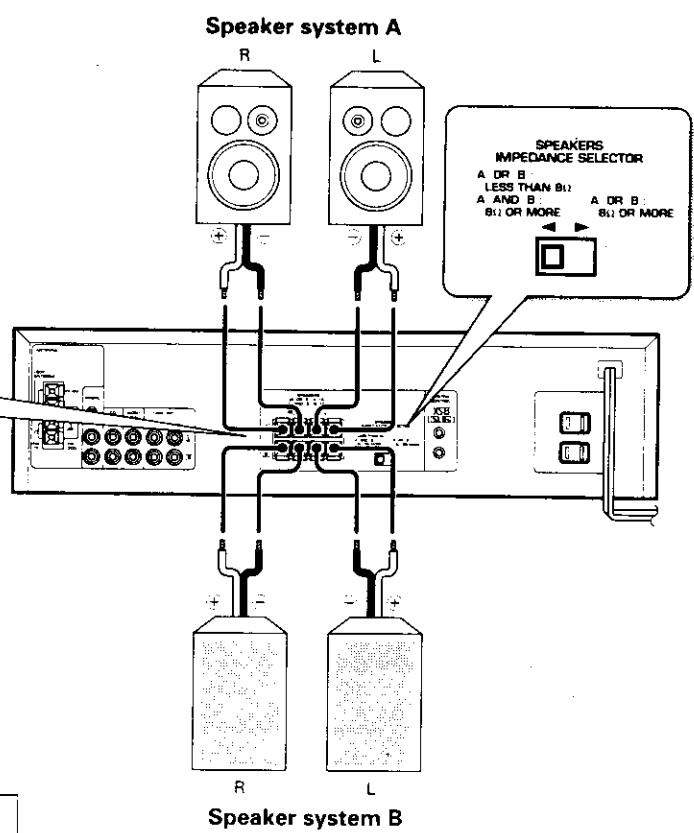
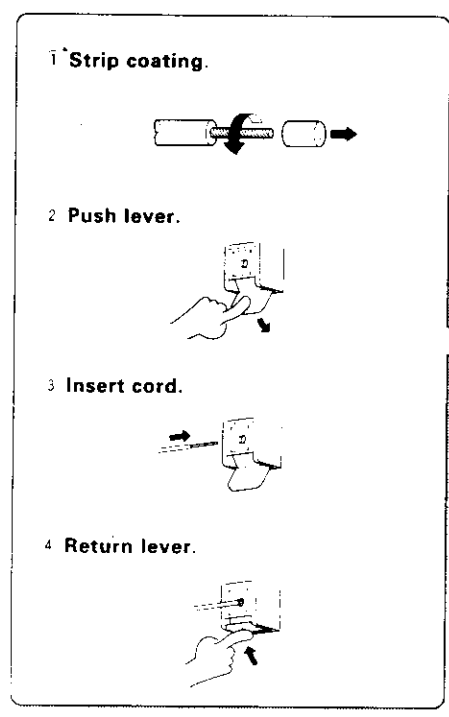

Speaker protection circuitry

If the speaker cords are short-circuited, the speaker protection circuitry is activated and the sound is muted. If this occurs, switch the **POWER** key to OFF, remove the short-circuit from the speaker cords, and switch the **POWER** key to ON again. Normal operation will resume.

- Never short-circuit the + and - speaker cords
- If the left and right speakers are connected inversely or if the speaker cords are connected with reversed polarity, the sound becomes unnatural with ambiguous acoustic image positioning. Be sure to connect the speakers and speaker cords correctly

Setting the speaker IMPEDANCE SELECTOR

When using the speaker A or speaker B separately

Speaker impedance	Selector position
4 Ω, 6 Ω	
8 Ω, 16 Ω	

When using the speaker A and B simultaneously

Speaker impedance	Selector position
8 Ω, 16 Ω	

CAUTION: TO PREVENT FIRE OR DAMAGE REQUIRING SERVICE, SET THE IMPEDANCE SELECTOR SWITCH AS DESCRIBED BELOW.

According to the impedance of the speakers used, set the speaker **IMPEDANCE SELECTOR** on the rear panel as shown in the table.

- When the **IMPEDANCE SELECTOR** switch is set to "**A or B: LESS THAN 8Ω, A and B: 8Ω OR MORE**", it is possible to use the A and B speakers at the same time. Therefore, when using the speakers A and B simultaneously, be sure to set the **IMPEDANCE SELECTOR** switch to the "**A or B: LESS THAN 8Ω, A and B: 8Ω OR MORE**" position
- During speaker system connection and operation of the speaker **IMPEDANCE SELECTOR**, set the **REMOTE POWER** key to OFF.

Connection of antenna

Connection method to each antenna terminal

1 Push lever.

2 Insert cord.

3 Return lever.

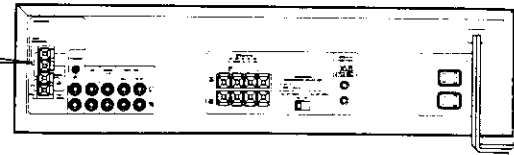
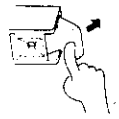

AM loop antenna connection

The supplied antenna is for indoor use. Place it as far as possible from the main system, TV set, speaker cords and power cord, and set it to a direction which provides the best reception.

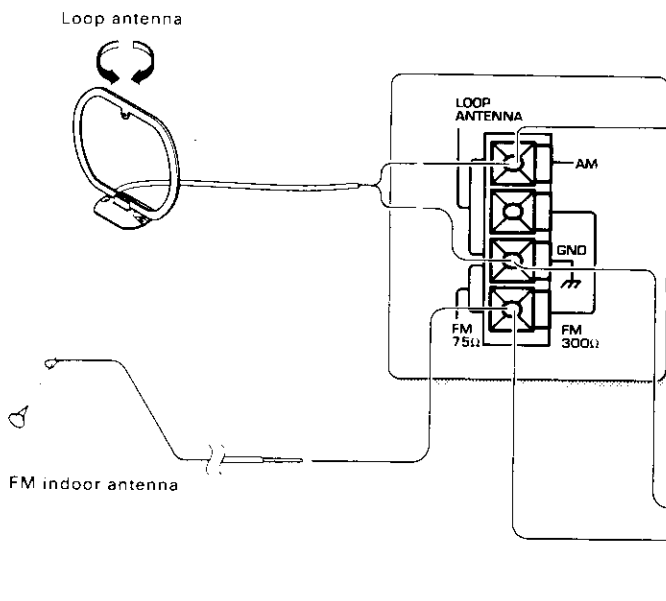

AM outdoor antenna connection

If the reception is poor when the AM loop antenna is used, distribute a vinyl-coated wire of more than 6 meters outdoors, without disconnecting the loop antenna.

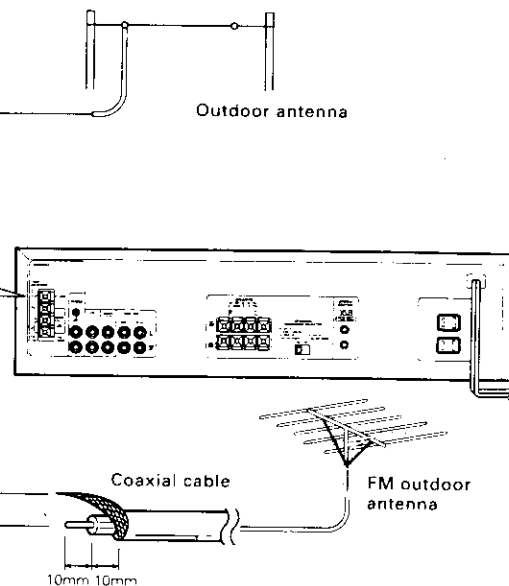

FM indoor antenna connection

The accessory antenna is for temporary indoor use only. For stable signal reception we recommend using an outdoor antenna. Remove the indoor antenna if you connect one outdoors.

FM DE-EMPHASIS / CHANNEL SPACE switch (Except for U.S.A., Canada and Australia)

The FM DE-EMPHASIS / CHANNEL SPACE switch on the rear panel is set to the correct setting that prevails in the area to which the unit is shipped. However, if the FM DE-EMPHASIS / CHANNEL SPACE setting is not matched to the area where the unit is to be used, for instance, when you moved from area 1 to area 2 or vice versa, desired reception of AM / FM broadcasts is not expected. In this case, change the FM DE-EMPHASIS / CHANNEL SPACE setting in accordance with the area corresponding to the table. The FM DE-EMPHASIS is switched over at the same time.

- When changing the setting of the FM DE-EMPHASIS / CHANNEL SPACE switch, first disconnect the power cord of the amplifier, then reset the channel space switch, connect the power cord again, and turn the power on.

FM outdoor antenna connection

Lead the 75 Ω coaxial cable connected to the FM outdoor antenna into the room and connect it to the FM 75 Ω terminal.

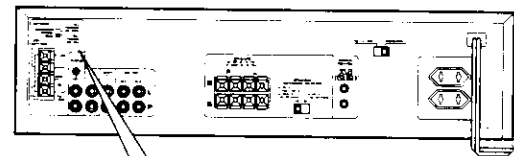

75 μs
FM 100kHz
AM 10kHz
50 μs
FM 50kHz
AM 9kHz

	Area	CHANNEL SPACE freq.	FM DE-EMPHASIS
1	U.S.A., Canada, Hawaii, South American countries	FM: 100kHz AM: 10kHz	75 μs
2	Other countries	FM: 50kHz AM: 9kHz	50 μs

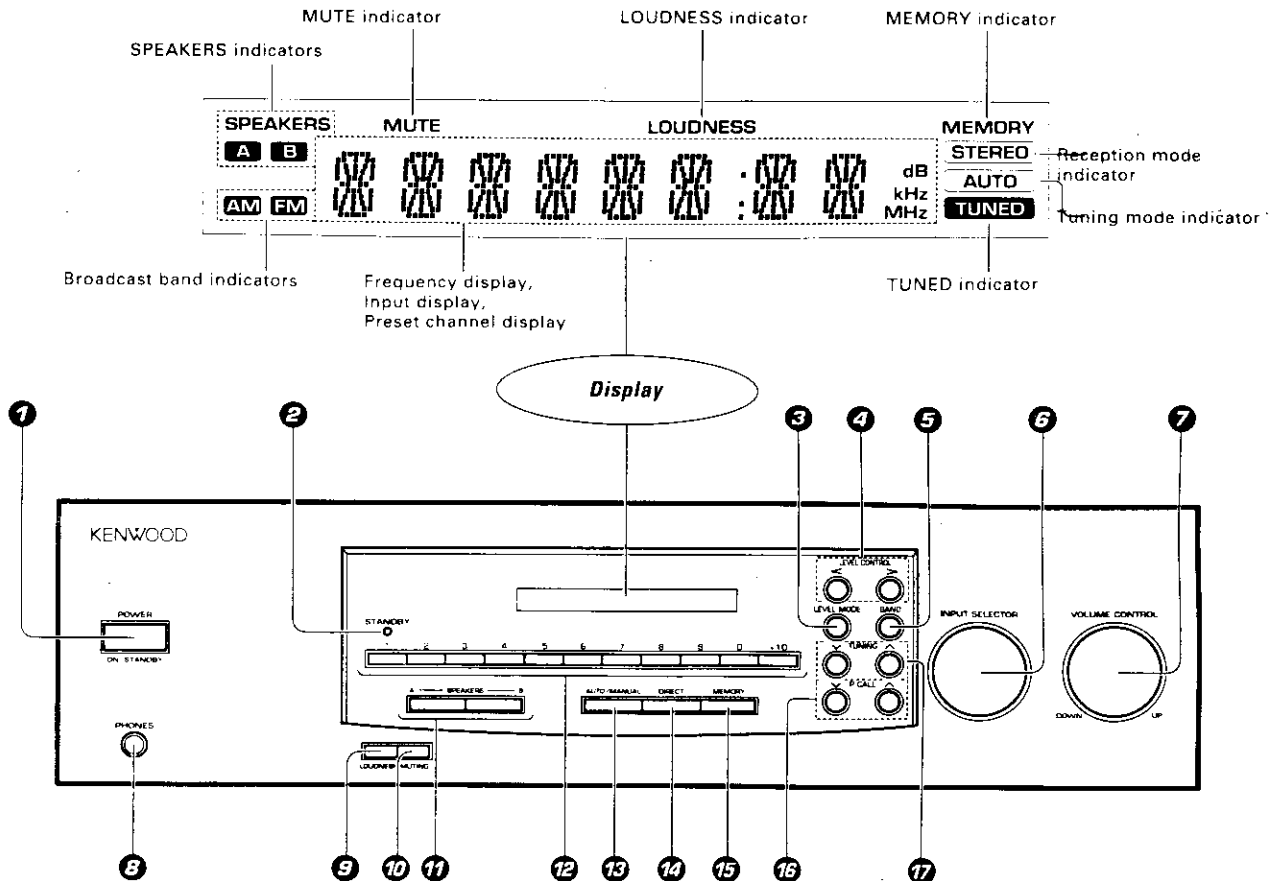

1 POWER key

Switches the power ON/OFF

2 STANDBY indicator

3 LEVEL MODE key

Press when adjusting the tone

4 LEVEL CONTROL keys

Press to adjust the tone

5 BAND key

Press to switch the broadcast band

6 INPUT SELECTOR knob

Turn to select the input sources

7 VOLUME CONTROL knob

8 PHONES jack

Used for headphone listening

9 LOUDNESS key

Press to enhance low frequencies

10 MUTING key

Press to mute sound temporarily

11 SPEAKERS A/B keys

Press to select the A and/or B speaker systems

12 Numeric keys

13 AUTO/MANUAL key

Press to select the auto tuning mode.

14 DIRECT key

Press for direct station tuning based on numerical input.

15 MEMORY key

Press to preset a station in the memory.

16 P. CALL keys

Recalls preset stations.

17 TUNING keys

Press to tune broadcast stations.

About the STANDBY indicator

This unit has a **STANDBY** indicator. When the **STANDBY** indicator is lit, the unit consumes a small amount of power to preserve the memory. This is called **STANDBY** mode. This mode also lets you turn the power ON/OFF using the remote control.

Remote control unit

The remote control unit provided with the receiver can also control KENWOOD cassette decks, and CD player connected to the receiver through system control cords. For details of the controllable functions, refer to the instruction manuals of these components.

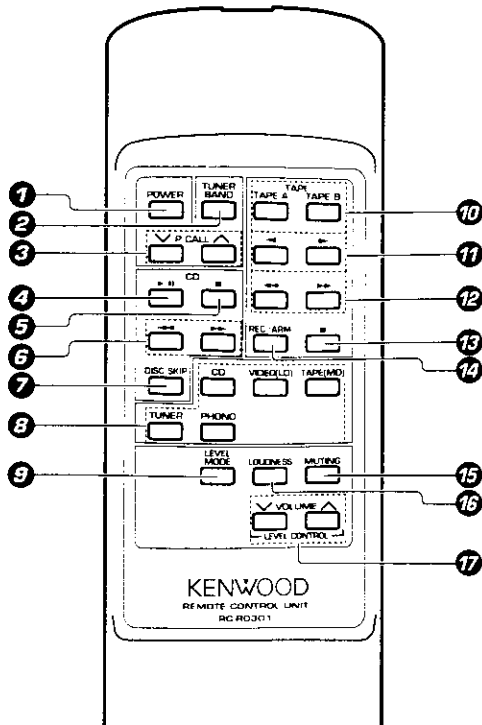

Model: RC-R0301
Infrared ray system

- ① **POWER key**
- ② **BAND key** - 13
Press to switch the broadcast band.
- ③ **P.CALL keys** - 15
Recalls preset stations.
- ④ **Play/pause key (▶/⏸) (CD)**
- ⑤ **Stop key (■) (CD)**
- ⑥ **Skip keys (◀◀, ▶▶) (CD)**
- ⑦ **DISC SKIP key (CD)**
For use as the disc skip key of the multi-CD player.
- ⑧ **Input selector keys** - 10
Press to select the inputs.
- ⑨ **LEVEL MODE key** - 11
Press when adjusting the tone.
- ⑩ **TAPE A/TAPE B keys (Cassette decks)**
- ⑪ **Play keys (◀, ▶) (Cassette decks)**
- ⑫ **Fast Forward/Rewind keys (◀◀, ▶▶) (Cassette decks)**
- ⑬ **Stop key (■) (Cassette decks)**
- ⑭ **REC/ARM key (Cassette decks)**
When recording on TAPE B, puts the deck in record-pause mode after leaving a non-recorded blank of 4 seconds.
- ⑮ **MUTING key** - 11
Press to mute sound temporarily.
- ⑯ **LOUDNESS key** - 11
Press to enhance low frequencies.
- ⑰ **VOLUME/LEVEL CONTROL keys** - 10 - 11
Press to adjust the volume. If the LEVEL MODE key is pressed before these keys, these keys can also be used to adjust the tone.

Loading batteries

- 1 Remove the cover.

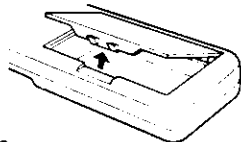

- 2 Insert batteries.

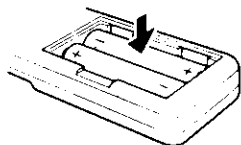

- Insert two AA-size (R6 / SUM-3) batteries as indicated by the polarity marking

- 3 Close the cover.

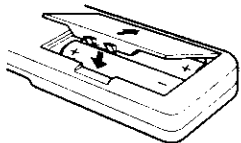

Operation procedure

When the **STANDBY** indicator is lit, the power turns **ON** when you press the **POWER** key on the remote. When the power comes **ON**, press the key you want to operate.

Approximate operating range

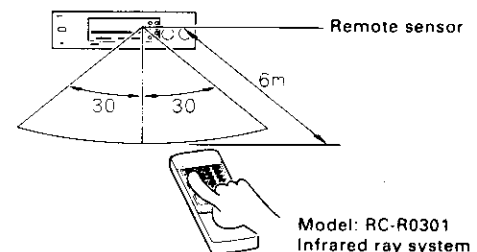

- When two operation keys on the remote control unit are pressed successively, press each key securely reserving an interval of more than 1 second for each press.



- 1 The supplied batteries are intended for use in operation checks. Therefore, their lives may be shorter than ordinary batteries.
- 2 When the remote-controllable distance gets shorter than before, replace both batteries with new ones.
- 3 Malfunction may occur if direct sunlight or the light of a high-frequency lighting fluorescent lamp enters the remote control light sensor. In such a case, change the system installation position to prevent the malfunction.

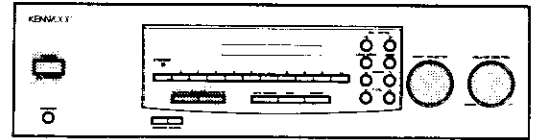

 : Keys or controls to be used in this operation

1 Turn the power ON.



2 Select the SPEAKERS key setting.

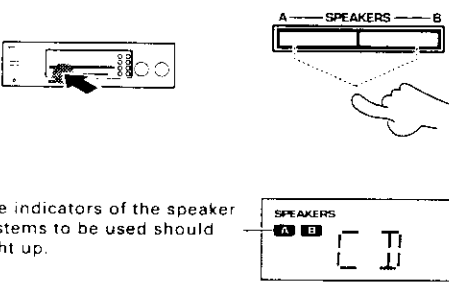

The indicators of the speaker systems to be used should light up.

3 Select the input source.

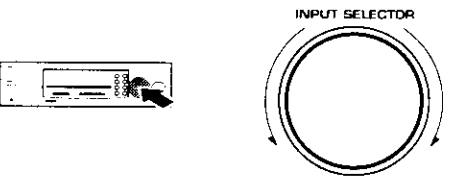

4 Play the selected source.

5 Adjust the volume.

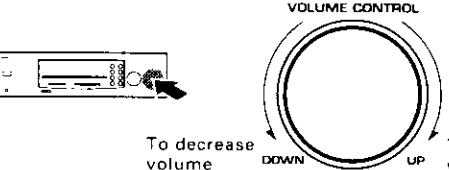

To decrease volume DOWN To increase volume UP

A, B OFF

Sound is not output from the speakers. Use this setting for listening through headphones, etc.

A ON

Sound is output from the speakers connected to the SPEAKERS A terminals on the rear panel.

B ON

Sound is output from the speakers connected to the SPEAKERS B terminals on the rear panel.

A, B ON

Sound is output from the speakers connected to the SPEAKERS A and B terminals on the rear panel.

The input sources are switched in the following order:

- 1 TUNER (frequency display)
- 2 PHONO
- 3 CD
- 4 VIDEO
- 5 TAPE (MD)*

The selected source is displayed.

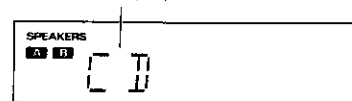

* If a KENWOOD MD recorder connected through the system remote control cord in the [SL16] mode, it is necessary to change the TAPE input to MD input using the following procedure.

- 1 Select the input name to be changed.
- 2 Press and hold the AUTO/MANUAL key for more than 2 seconds.

Sound adjustment functions

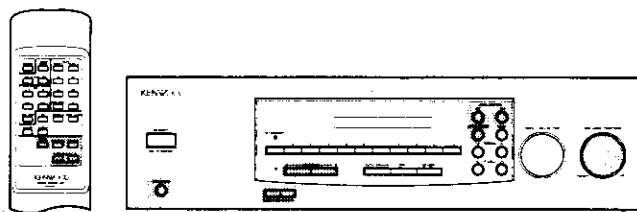

Fig. 1 : Keys or controls to be used in this operation

Adjusting the tone and left/right volume balance

1 Select the tone mode to be adjusted.

LEVEL MODE

Proceed to step 2 within 5 sec.
(If more than 5 sec. have elapsed, press the **LEVEL MODE** key again.)

2 Adjust.

LEVEL CONTROL

To enhance (To decrease the left sound)

To disenhance (To decrease the right sound)

Each press of the key switches the mode as follows:

1 **L--P--R** : The mode for adjusting the volume balance between the left and right.

Indicates the center. — Indicates the balance setting.

2 **BASS** : The mode for adjusting the low frequencies.

3 **TREBLE** : The mode for adjusting the high frequencies.

To listen through headphones

1 Set both of the **SPEAKERS** keys to OFF.

A SPEAKERS B

2 Plug headphones.

PHONES

3 Adjust the volume.

Compensating for low frequencies (LOUDNESS)

The **LOUDNESS** function is used to compensate for the low frequencies which are less audible during low-volume listening.

LOUDNESS MUTING

lights

To cancel

Press the **LOUDNESS** key again.

Goes off

To mute sound temporarily

LOUDNESS MUTING

Press again to return to the original volume.

blinks

SPEAKERS A MUTE

To cancel

Press the **MUTE** key again.

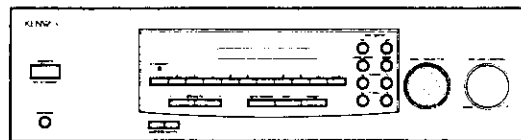

 : Keys or controls to be used in this operation

To record a music source

1 Select the source to be recorded.



INPUT SELECTOR

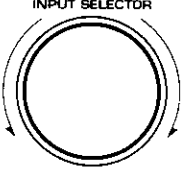

Select an input source other than TAPE.

2 Put the cassette deck in record-pause mode.

3 Play the source and start recording.

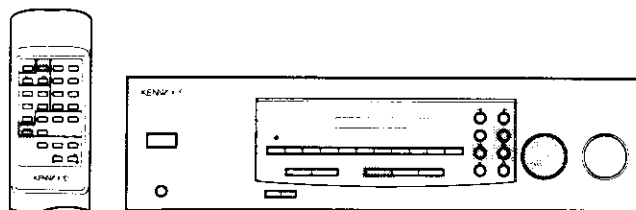

: Keys or controls to be used in this operation

Receiving broadcast stations

1 Select the TUNER input.

2 Select the broadcast band.

3 Select the tuning method.

4 Select a station.

The input sources are switched in the following order

- 1 TUNER (frequency display)
- 2 PHONO
- 3 CD
- 4 VIDEO
- 5 TAPE (MD)

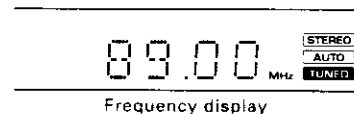

- The last frequency tuned before is displayed.

Each press switches the band as follows:

- 1 FM
- 2 AM

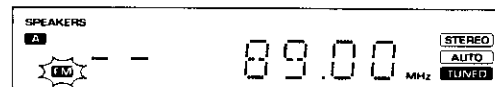

"AM" or "FM" indicator

Each press switches the turning method as follows:

- 1 AUTO lit (auto tuning)
- 2 AUTO not lit (manual tuning)

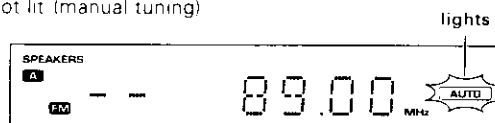

- Usually, set the switch to **AUTO** (auto tuning).

Select manual tuning when noise interferes due to weak radio wave. (The stereo broadcasting is received in monaural during manual tuning.)

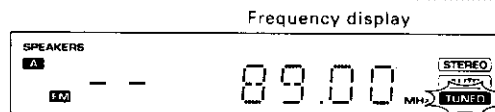

"TUNED" lights up when a station is tuned.

For Auto Tuning: Press ∇ or \wedge once and the tuner automatically tunes to a receivable station.

For Manual Tuning: Press repeatedly until the frequency you desire is tuned. You can also tune by holding the button down.

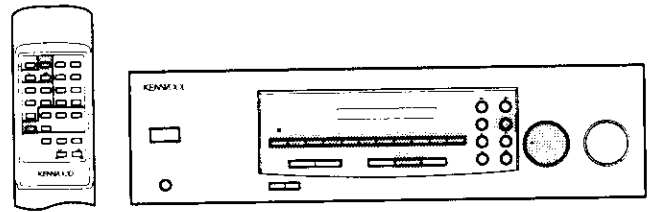

Ⓚ : Keys or controls to be used in this operation

Receiving radio stations by specifying its frequency

1 Select the TUNER input.

2 Select the broadcast band.

3 Specify the frequency.

1 Press the DIRECT key.

2 Enter the frequency of the desired station.

The input sources are switched in the following order:

- 1 TUNER (frequency display)
- 2 PHONO
- 3 CD
- 4 VIDEO
- 5 TAPE (MD)

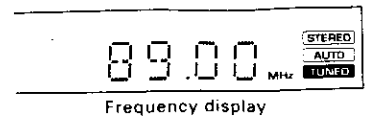

Each press switches the band as follows:

- 1 FM
- 2 AM

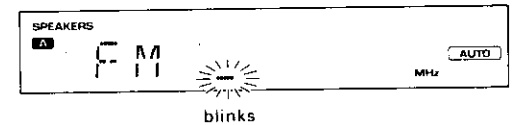
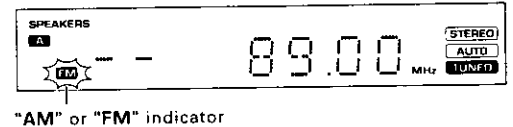

Press the numeric keys according to the frequency to be tuned as shown below.

- *AM10kHz/FM100kHz territories (U.S.A., Canada, etc.)
- AM 810 kHz 8 . 1 (10 kHz space)
 - AM 1260 kHz 1 . 2 . 6 (10 kHz space)
 - FM 90 MHz 9 . 0 . 0 (100 kHz space)
 - FM 102.5 MHz 1 . 0 . 2 . 5 (100 kHz space)

- *AM9kHz/FM50kHz territories (other countries)
- AM 810 kHz 8 . 1 . 0 (9 kHz space)
 - AM 1260 kHz 1 . 2 . 6 . 0 (9 kHz space)
 - FM 90 MHz 9 . 0 . 0 . 0 (50 kHz space)
 - FM 102.5 MHz 1 . 0 . 2 . 5 . 0 (50 kHz space)

*FM DE-EMPHASIS/CHANNEL SPACE switch

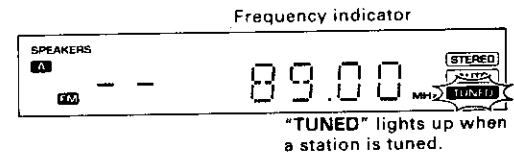

- If you make a mistake, the frequency display blinks for a few seconds. In this case, repeat step 3 from the beginning.

Preparation

- Tune the station to be stored in memory.

- 13



Keys or controls to be used in this operation

Storing radio stations in memory (Station preset)

1 Press the MEMORY key during receiving a station.

2 Select one of the preset numbers from 1 to 40.

Proceed to step 2 within 5 sec.
(If more than 5 sec. have elapsed, press the MEMORY key again.)

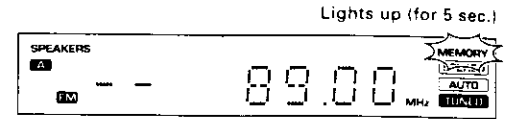

Press the numeric keys in the following order.

- To store in "15" ... [+10] [5] [0]
- To store in "20" ... [+10] [+10] [0]

- Repeat steps 1 and 2 for each of the stations to be stored in memory.
- You can store a combined total of up to 40 FM and AM stations.
- If a station is stored in a preset number which has already stored a station memory under it, the previous memory is replaced by the new memory content.

Receiving a preset station

1 Select the TUNER input with the INPUT SELECTOR.

2 Press the preset number of the desired station.

Press the numeric keys in the following order

- To recall "15" ... [+10] [5] [0]
- To recall "20" ... [+10] [+10] [0]

- If you make a mistake in entering the figure of 10, press the [+10] key repeatedly until the original display is shown, then enter the correct number.

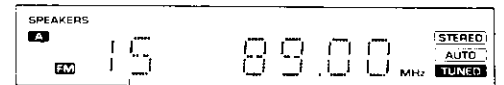

Preset number stored in memory

Receiving all preset stations in order

Press the P. CALL key.

- Every time the key is pressed, the next station in the order of the preset number is received

When you press ^ key, ... 1 → 2 → 3 ... 38 → 39 → 40

When you press v key, ... 1 → 2 → 3 ... 38 → 39 → 40

If the key is held pressed, ... Preset stations will be received successively for about half a second each.

In case of difficulty

103AR (En)

Operation to reset

The microcomputer may fall into malfunction (impossibility to operate, erroneous display, etc.) when the power cord is unplugged while power is ON or due to an external factor. In this case, execute the following procedure to reset the microcomputer and return it to normal condition.

Unplug the AC power cord from the wall outlet, then plug it back in while holding down the MEMORY key.

- Please note that resetting the microcomputer clears the contents stored in it returns it to the condition when it left the factory.

Remote control unit

Symptom	Cause	Remedy
Remote control operation is not possible.	<ul style="list-style-type: none"> ● Batteries are exhausted. ● The remote control unit is too far away from the main system, controlling angle is too large, or there is an obstacle in between. ● The audio cords and system control cords are not connected properly. ● The source component to be operated does not contain the tape(s) or CD. ● An attempt is made to play a tape which is being recorded in the cassette deck. 	<ul style="list-style-type: none"> ● Replace with new batteries - 9 ● Operate the remote control unit within the controllable range ● Connect properly referring to "System connections" - 4 ● Place the tape(s) or CD in the source component to be played. ● Wait until the recording is completed.

Amplifier

Symptom	Cause	Remedy
Sound is not output.	<ul style="list-style-type: none"> ● The speaker cords are disconnected ● The VOLUME is set to the minimum position ● The SPEAKERS switches are set to OFF 	<ul style="list-style-type: none"> ● Connect them properly referring to "System connections" ● Adjust the volume to a proper level ● Set the SPEAKERS switches to ON
The STANDBY indicator blinks and sound is not output.	<ul style="list-style-type: none"> ● Speaker cords are short-circuited 	<ul style="list-style-type: none"> ● Turn the power off, eliminate the short-circuiting, then turn on the power again. - 6
Sound is not output from one of the speakers.	<ul style="list-style-type: none"> ● The speaker cord is disconnected ● The BALANCE control is set to an extreme position. 	<ul style="list-style-type: none"> ● Connect it properly referring to "System connections" ● Adjust the Left/Right balance.
A hum noise is generated when the PHONO input selector is selected.	<ul style="list-style-type: none"> ● The audio cord from the turntable is not inserted securely into the PHONO jacks ● The turntable is not grounded 	<ul style="list-style-type: none"> ● Insert the audio cord plugs securely into the PHONO jacks ● Connect the grounding wire to the GND terminal on the rear panel

Tuner

Symptom	Cause	Remedy
Radio stations cannot be received.	<ul style="list-style-type: none"> ● No antenna is connected. ● The broadcast band is not set properly ● The frequency of the desired station is not tuned 	<ul style="list-style-type: none"> ● Connect an antenna ● Set the broadcast band properly ● Tune the frequency of the desired station. - 13
Interference.	<ul style="list-style-type: none"> ● Noise due to ignition noise of an automobile ● Noise due to an influence from an electric appliance ● Noise due to a nearby TV set 	<ul style="list-style-type: none"> ● Install the outdoor antenna away from the road ● Turn off the power to the appliance ● Install the system farther away from the TV set
A station which was preset cannot be received by pressing the corresponding numeric key.	<ul style="list-style-type: none"> ● The preset station belongs to a frequency that cannot be received ● The preset memory was cleared because the power cord had been unplugged for a long period of time. 	<ul style="list-style-type: none"> ● Preset a station with a receivable frequency ● Preset the station again



Do not use contact cleaners because it could cause a malfunction. Be specially careful against contact cleaners containing oil, for they may deform the plastic components.

Specifications (For The U.S.A. and Canada)

Caution: Read this page carefully to ensure safe operation.

1Q3AR (En)

Audio section

Rated power output at the STEREO operation

50 watts per channel minimum RMS, both channels driven at 8 Ω , from 30 Hz to 20,000 Hz with no more than 0.09 % total harmonic distortion. (FTC)

Total harmonic distortion	0.03 % (1 kHz, 25 W, 8 Ω)
Signal to noise ratio (IHF'66)	
PHONO (MM)	75 dB
LINE (CD, VIDEO, TAPE)	93 dB
Input sensitivity / impedance	
PHONO (MM)	2.5 mV / 47 k Ω
LINE (CD, VIDEO, TAPE)	200 mV / 47 k Ω
Tone controls	
BASS	± 8 dB (at 150 Hz)
TREBLE	± 8 dB (at 10 kHz)
LOUDNESS control at - 30 dB VOLUME level	
	+ 6 dB (150 Hz)

FM Tuner section

Tuning frequency range	87.5 MHz ~ 108 MHz
Usable sensitivity	
MONO	1.4 μ V (75 Ω) / 14.2 dBf (75 kHz dev., S/N 30 dB)
50 dB quieting sensitivity	
STEREO	44 μ V (75 Ω) / 44.2 dBf (75 kHz dev.)
Total harmonic distortion (1 kHz)	
MONO	0.6 % (65.2 dBf input)
STEREO	0.7 % (65.2 dBf input)
Signal to noise ratio (1 kHz, 75 kHz dev.)	
MONO	75 dB (65.2 dBf input)
STEREO	68 dB (65.2 dBf input)
Stereo separation	
1 kHz	40 dB
Selectivity (± 400 kHz)	50 dB
Frequency response	30 Hz ~ 15 kHz, + 0.5 dB, - 3.0 dB

AM Tuner section

Tuning frequency range	530 kHz ~ 1,700 kHz
Usable sensitivity (30 % mod., S/N 20 dB)	
	20 μ V / (560 μ V / m)
Total harmonic distortion	0.7 %
Signal to noise ratio (30 % mod., 1 mV input)	48 dB
Selectivity	30 dB

General

Power consumption	130 W
AC outlet	
SWITCHED	2: (total 150 W, 1.25 A max.)
Dimensions	W:440 mm (17-5/16")
	H:127 mm (5")
	D:380 mm (14-15/16")
Weight (net)	6.9 kg (15.2 lb)



KENWOOD follows a policy of continuous advancements in development. For this reason specifications may be changed without notice

Memory backup function

Please note that the following items will be deleted from this unit's memory if the power cord is disconnected from the AC outlet for approximately three days.

- POWER status (ON or OFF)
- System control mode setting ([XS8] or [SL16])
- Input setting
- Volume level
- Receiving band
- Frequency
- Preset stations

For the U.S.A.**FCC WARNING**

This equipment may generate or use radio frequency energy. Changes or modifications to this equipment may cause harmful interference unless the modifications are expressly approved in the instruction manual. The user could lose the authority to operate this equipment if an unauthorized change or modification is made.

NOTE:

This equipment has been tested and found to comply with the limits for a Class B digital device, pursuant to Part 15 of the FCC Rules. These limits are designed to provide reasonable protection against harmful interference in a residential installation. This equipment may cause harmful interference to radio communications, if it is not installed and used in accordance with the instructions. However, there is no guarantee that interference will not occur in a particular installation. If this equipment does cause harmful interference to radio or television reception, which can be determined by turning the equipment off and on, the user is encouraged to try to correct the interference by one or more of the following measures:

- Reorient or relocate the receiving antenna.
- Increase the separation between the equipment and receiver.
- Connect the equipment into an outlet on a circuit different from that to which the receiver is connected.
- Consult the dealer or an experienced radio / TV technician for help.

For the U.S.A.**Note to CATV system installer:**

This reminder is provided to call the CATV system installer's attention to Article 820-40 of the NEC that provides guidelines for proper grounding and, in particular, specifies that the cable ground shall be connected to the grounding system of the building, as close to the